



GT20-3HD

Sealed Maintenance Free Battery

Features

- Advanced sulfate-resistant technology.
- Advanced calcium lead alloy technology.
- Maintenance-free design.
- Factory activated, Ready to install and go!
- Absorbed Glass Mat (AGM) technology.

Performance Specifications

Nominal Voltage ----- 12 volts

Nominal Capacity 25°C (77°F)

20-hr. (1A to 10.5 volts) -----	21.6AH
10-hr. (2A to 10.5 volts) -----	20AH
5-hr. (4A to 10.2 volts) -----	16.4AH
1C. (20A to 9.6 volts) -----	9AH
3C. (60A to 9.6 volts) -----	7.2AH

Approximate Weight ----- 12.76bs. (5.8kg)

Cranking (by Tester) ----- 415Amperes

Cold Cranking (-18°C) ----- 250Amperes

Internal Resistance(at 1KHz) ----- Approx.5.9mΩ

Operating Temperature Range

Discharge ----- -22°F(-30°C) to 122°F(50°C)

Charge ----- 32°F(0°C) to 104°F(40°C)

Life Expectancy (Cycle Use)

60% depth of discharge ----- 250 cycles

30% depth of discharge ----- 400 cycles

Shelf Life (% of normal capacity at 68°F(20°C).....SOC% ocv)

1 months ----- 91% 12.78V

3 months ----- 89% 12.70V

6 months ----- 80% 12.5V

Warranty ----- 1 year

Case ----- ABS



Terminal Dimensions: (in./mm)

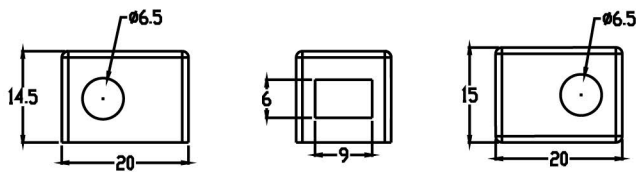

Physical Dimensions: (in./mm)

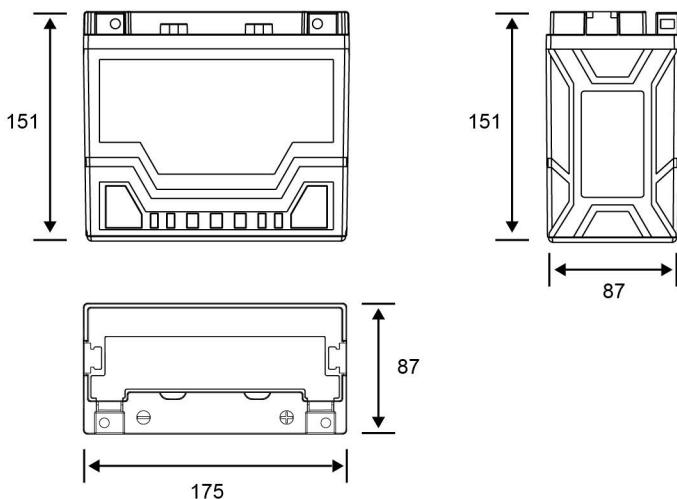

Length:6.89in(175mm) Width:3.43in(87mm)

Height:5.94in(151mm)

Tolerances are ±0.04 inches (±1mm) and ±0.08 inches (±2mm) for height.

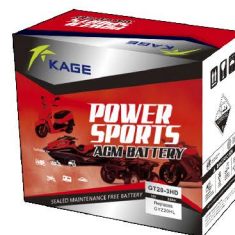

Inner box

Screws and nuts



Shelf life & Storage

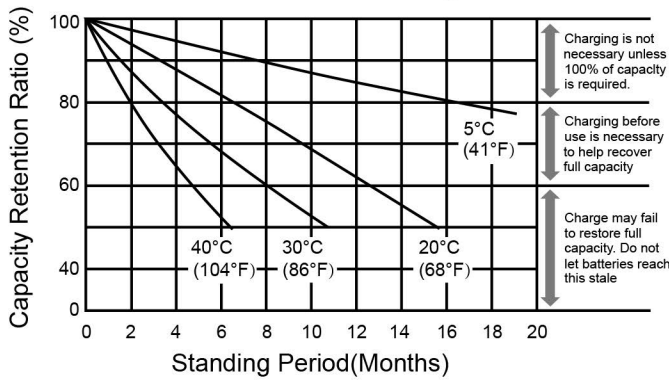

Discharge Characteristics

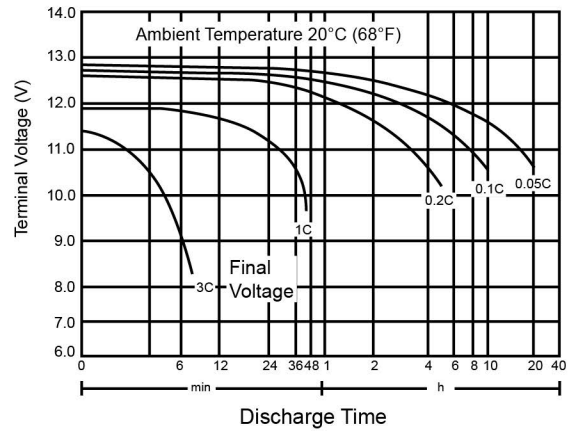

Discharge Time vs. Discharge Current

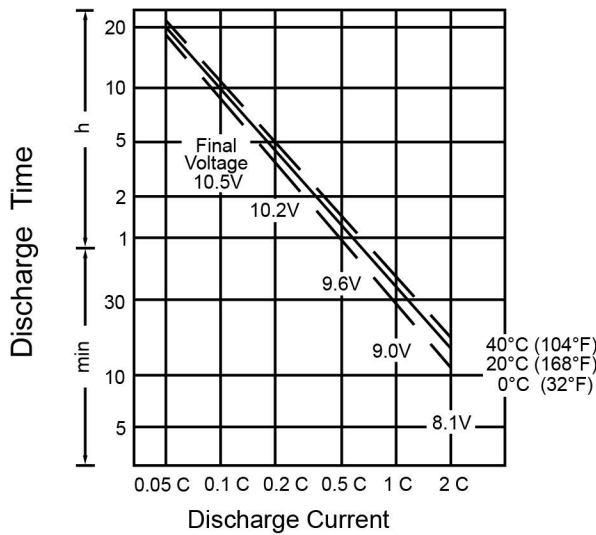

Life Characteristics in Cyclic Use

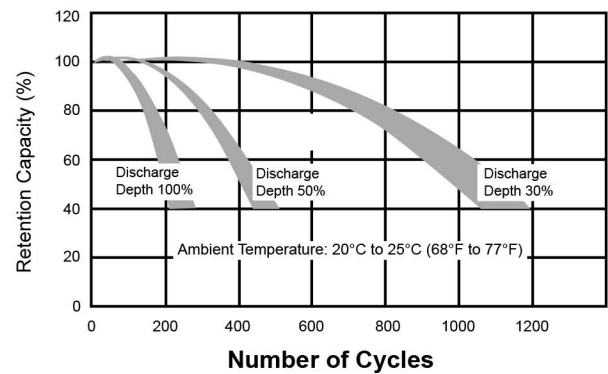

Charging

Cycle Applications: Limit initial current to 0.2C. Charge until battery voltage (under charge) reaches 14.8 to 15.0 volts at 68°F (20°C). Hold at 14.8 to 15.0 volts until current drops to under 50 mA. Battery is fully charged under these conditions, and charger should be disconnected or switched to "float" voltage.

Note: Due to the self-discharge characteristics of this type of battery, it is imperative that they be charged within 6 months of storage, otherwise permanent loss of capacity might occur as a result of sulfation.

Further information:

Please contact our technical department for advice if you have difficulty or contact us at kaijie@kaijie.net

Can be used to replace:

GYZ20HL			